

Puzzle Sounds

SUPER HARD ON BOOSTER



SUPER HARD ON BOOSTER

We hope you enjoy your new SUPER HARD ON BOOSTER! In this manual, you will find documentation and guidelines helpful to put it together.

Here we have put together a few links that detail some of the aspects explained in this manual and that we think you can find helpful:

[Kit & PuzzleKit general manual](#)

[Reading resistor and capacitor values](#)

Also, in our blog you can find multiple articles regarding tips for soldering, more in-depth posts about resistors and capacitors...

[Check it out!](#)

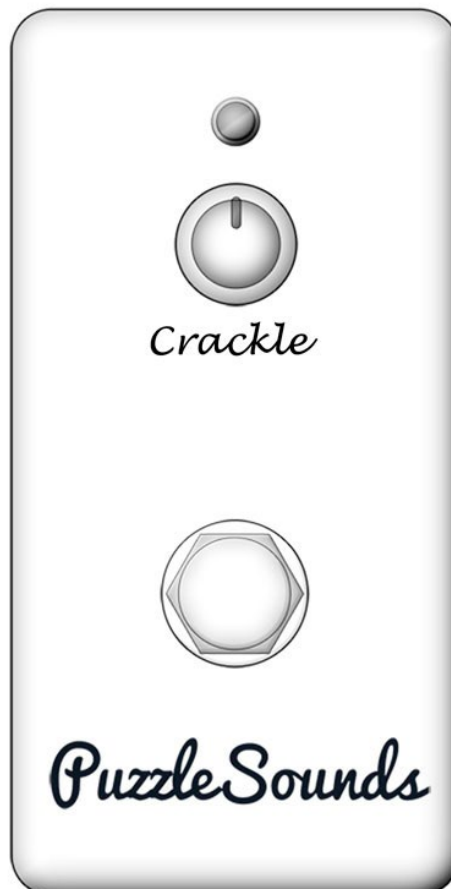

SUPER HARD ON BOOSTER

Bill Of Materials

Resistors (4)

2	R1, R2	10M	
1	R3	5.1k	
1	R4	100k	

Capacitors (2)

1	C1	100n	
1	C2	10u	(electrolytic)

Transistors (1)

1	Q1	BS170	
---	----	-------	--

Diodes (2)

2	D1, D2	1N914/1N4148	
---	--------	--------------	--

Potentiometers

1	CRACKLE	5kB (lin.)	
---	---------	------------	--

Other (2)

1	DP	1N4007	
1	RON	1k	

SUPER HARD ON BOOSTER

Part Placement

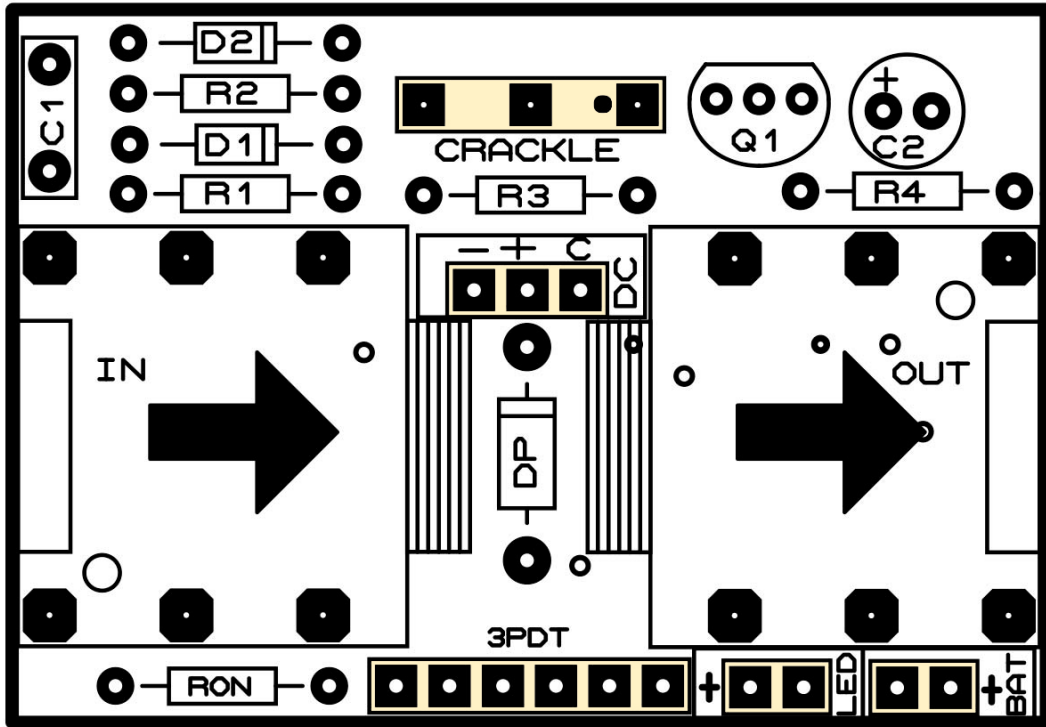

STEP 1 - Resistors and diodes

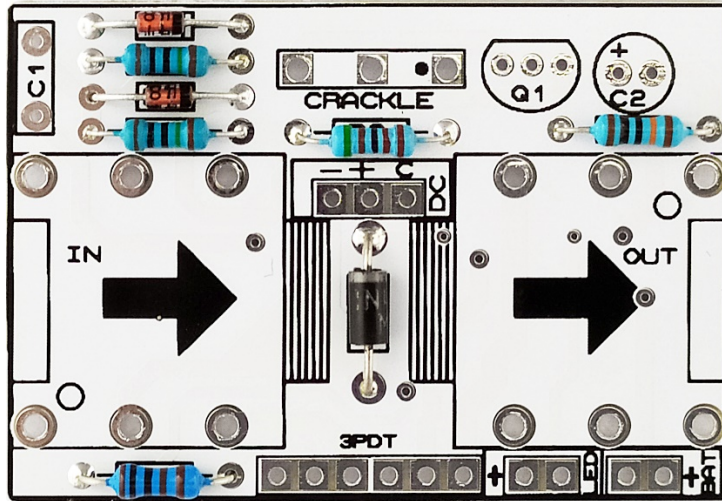

Place the resistors and diodes. If you have troubles reading the values, check out our ["Reading Part Values"](#) tutorial.

Resistors (4)

- 2 R1, R2
- 1 R3
- 1 R4

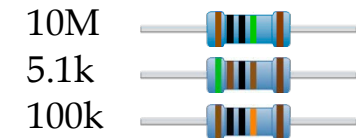

Other (2)

- 1 DP
- 1 RON



STEP 2 - Pin header

Then, connect the 6 pin header:

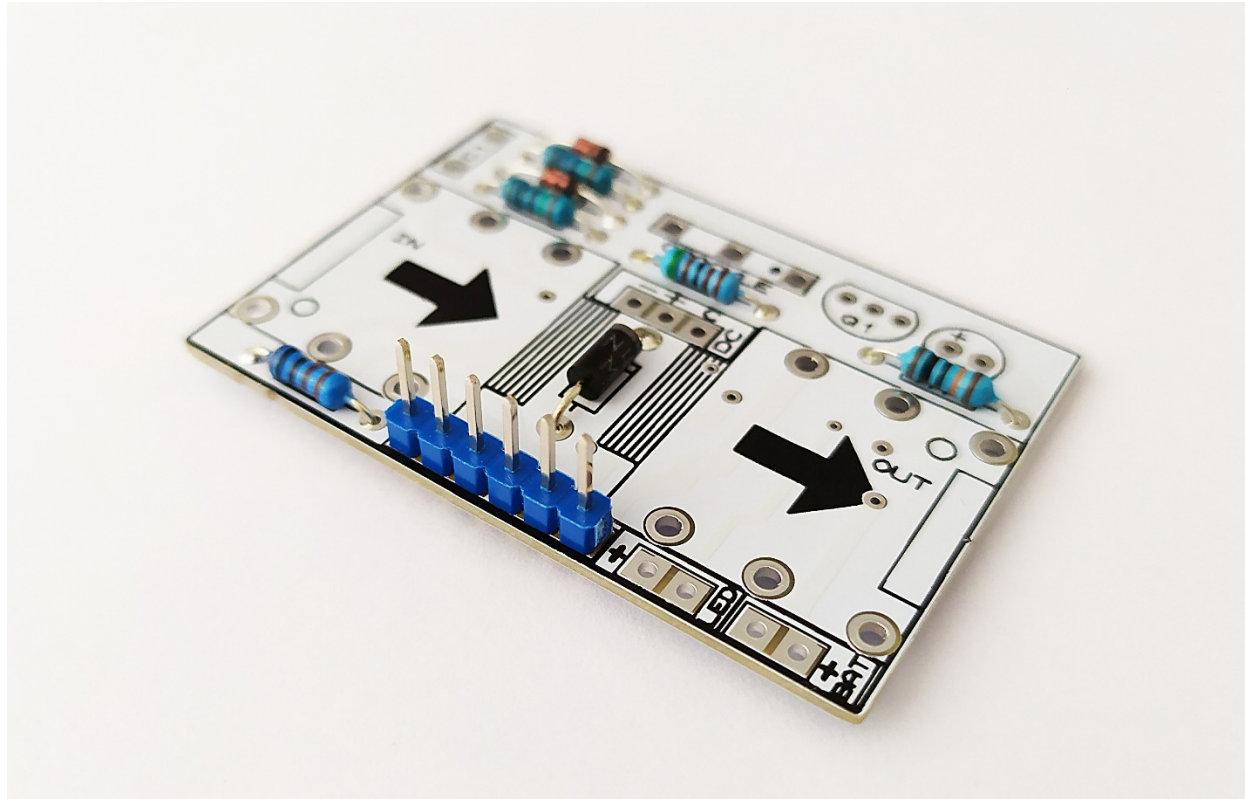

STEP 3 - Capacitors and Transistors

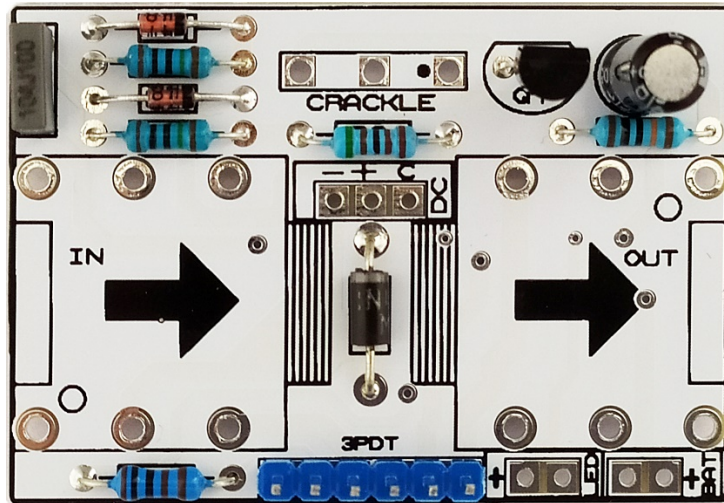

Solder the capacitors and transistors. If you have troubles reading the values, check out our [“Reading Part Values”](#) tutorial. Pay attention to the orientation, as well as to the polarity for electrolytic capacitors.

Capacitors (2)

1	C1	100n
1	C2	10u (electrolytic)

Transistors (1)

1	Q1	BS170
---	----	-------

STEP 4 - LED and Battery Clip

Solder two wires to the LED connection (red to the “+” sign).

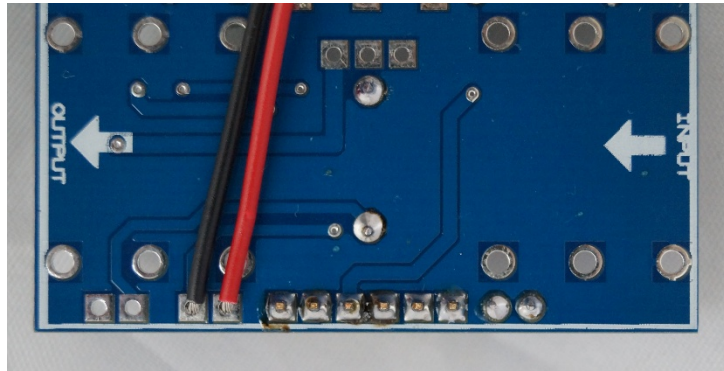

Then, solder them to the LED (the red wire is connected to the longer pin).

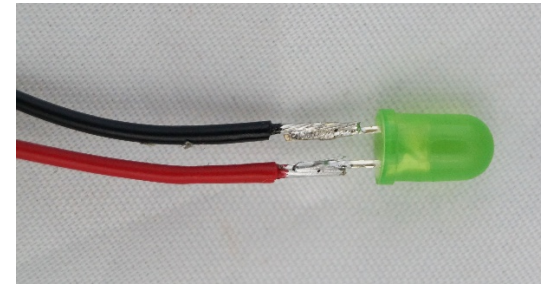

Solder the battery clip, connecting the red wire to the “+” sign:

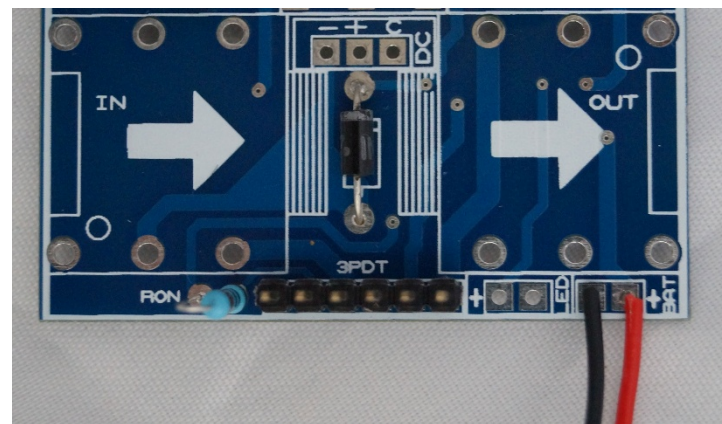

STEP 5 - DC Power Jack wires

Solder three wires (about 5cm each) to the DC connection as shown (don't solder anything to the other end yet!):

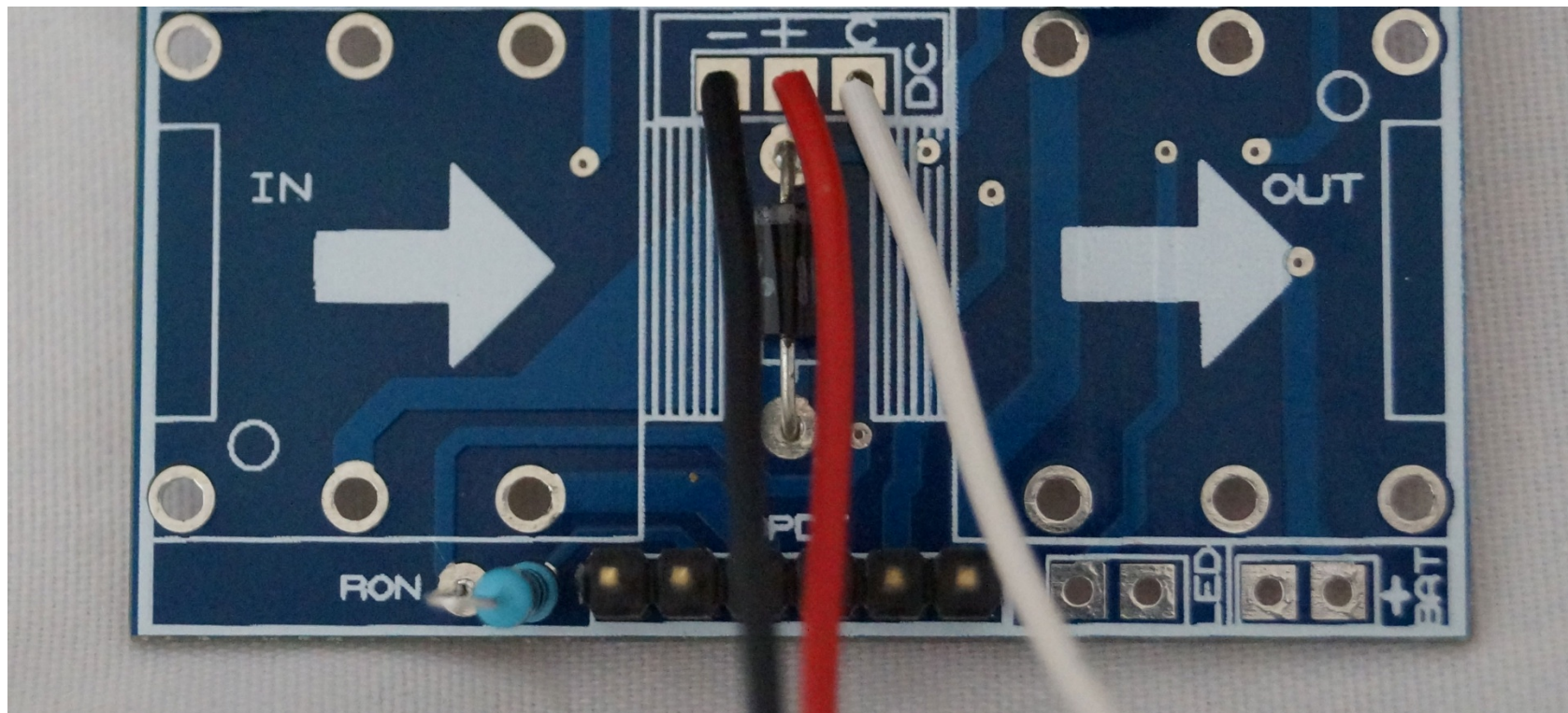

STEP 6 - Audio Jacks

Now, solder the audio jacks to the board (DC, battery and led wires are not present to make it clearer):

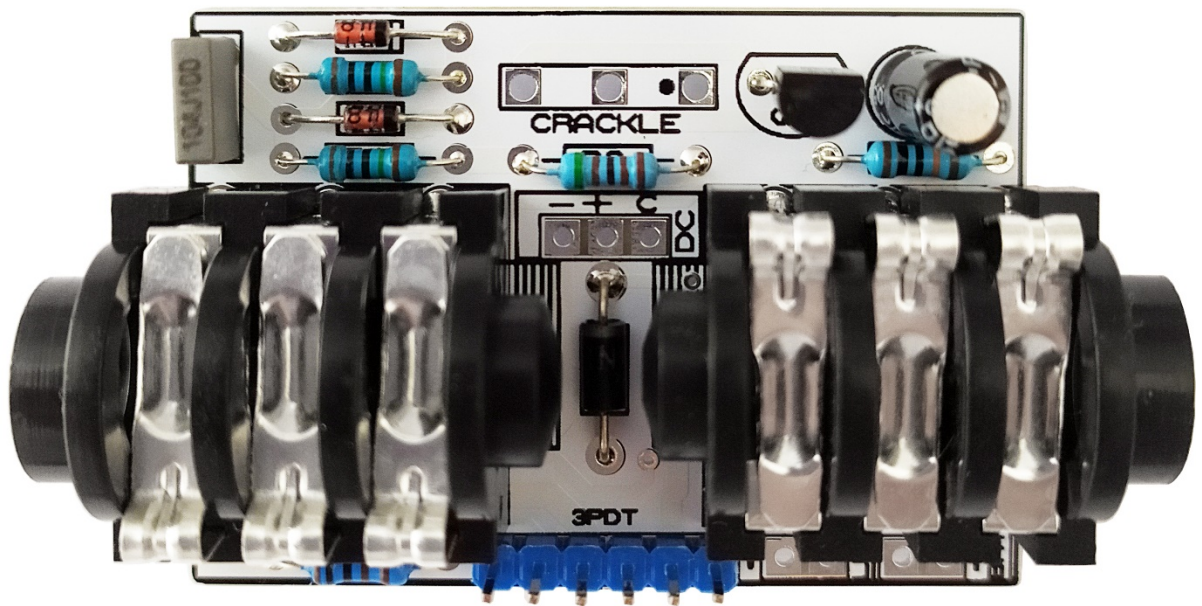

STEP 7 - Potentiometers

A - Preparing the potentiometers

Cut 3 pieces of wire for each potentiometer you have to solder (i.e. 9 pieces for 3 potentiometers). Then, solder them to each lug. The first lug is the one in the left in top view (the black wire in the picture).

Here, we've cut them short (~1cm), but you can use the length you need.

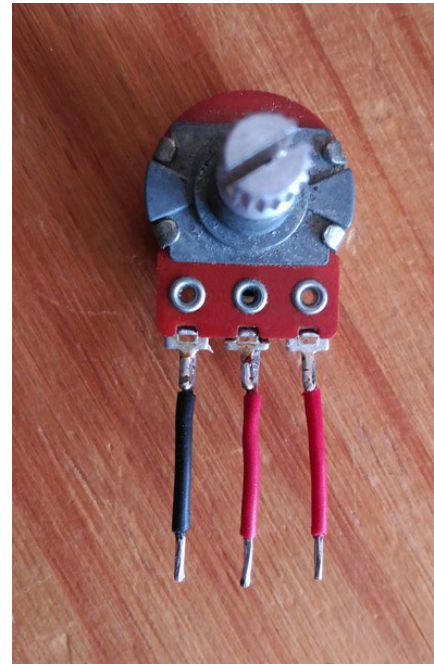

The pin 1 is shown in the PCB, either as a dot or as a "1" number (left picture). If your board doesn't specify a "1" or a dot, then the default 1 pins are being used. Below you can find the default pin 1 for our PCBs.

You can solder the potentiometers from above or from below (which we prefer) depending on how you plan to build the pedal.

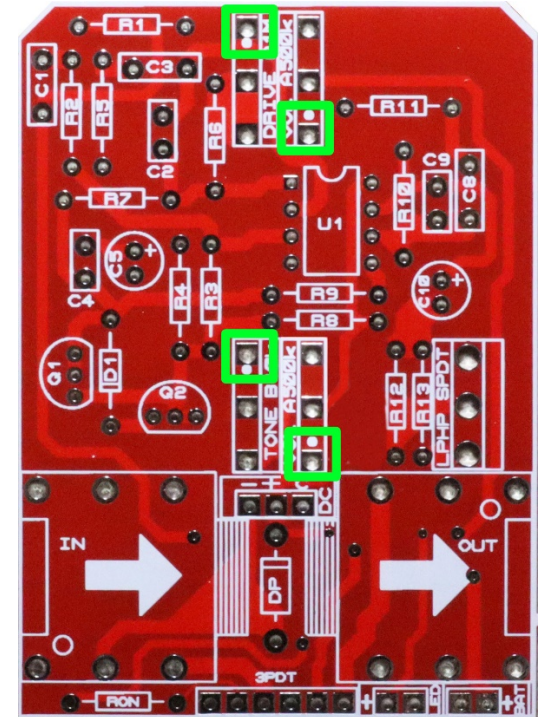
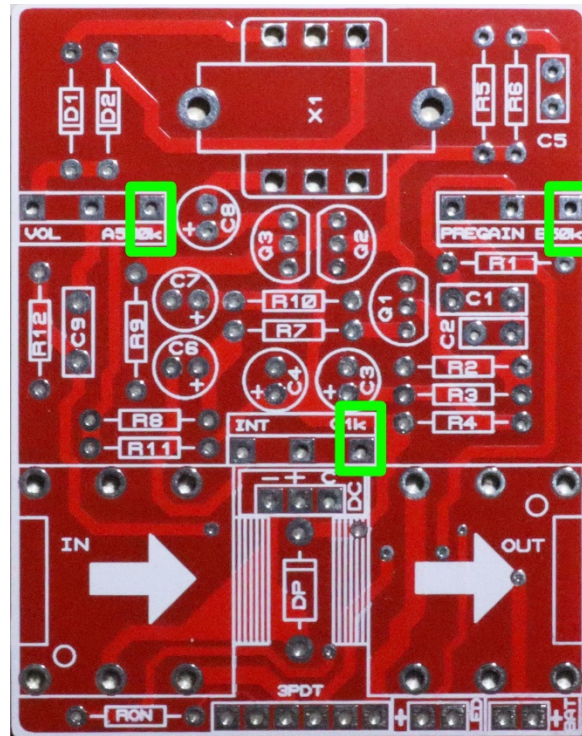
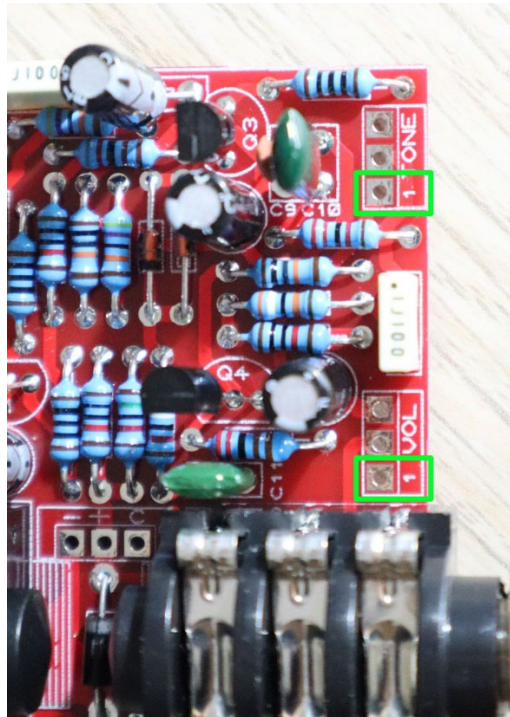

Then, solder them to the board like in the picture in the left, and then place the board inside the enclosure:

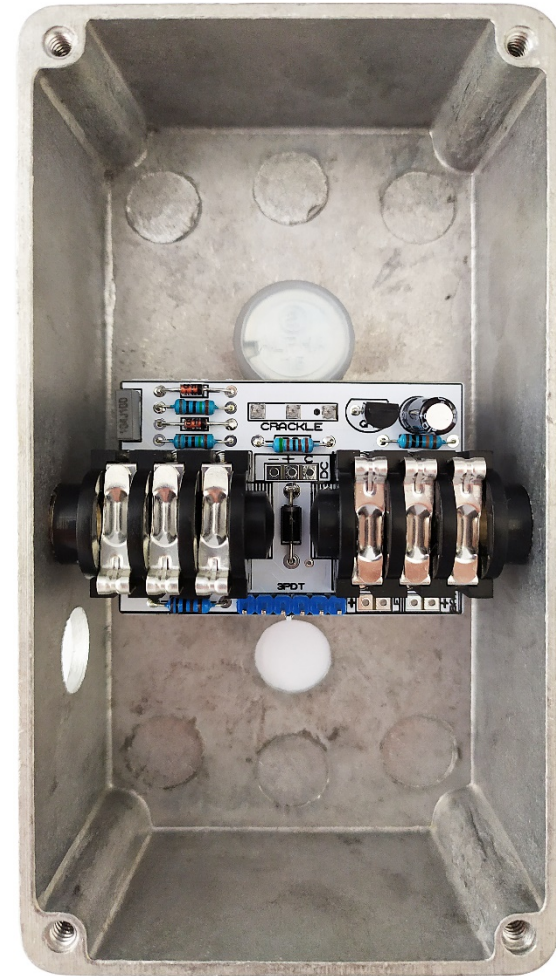
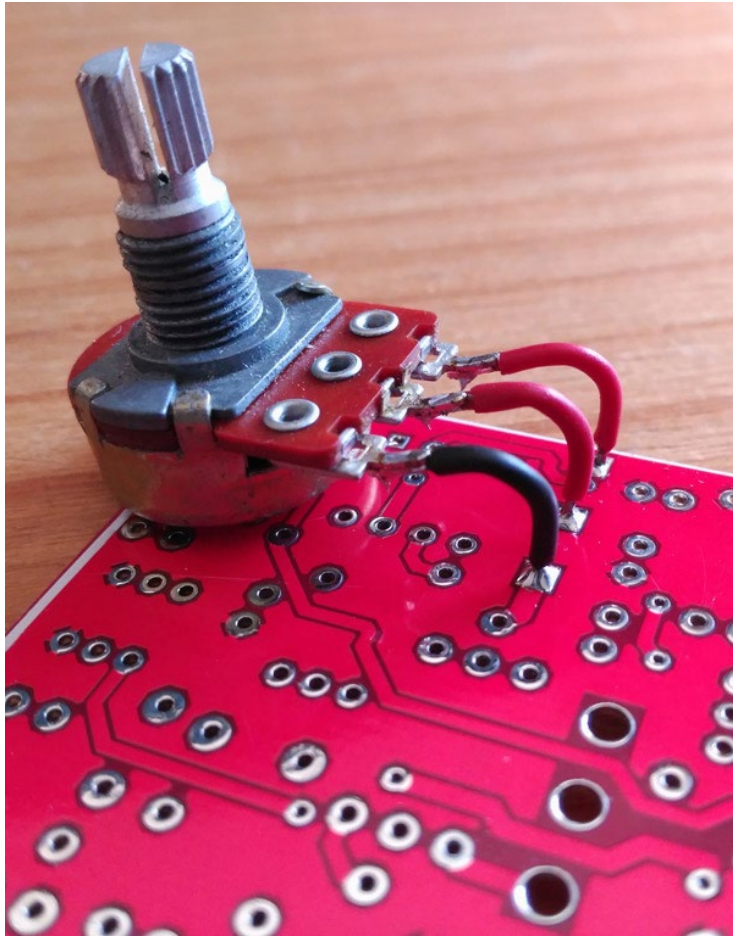

STEP 8 – DC Power Jack

First of all, insert the DC jack in the enclosure and tighten the nut:



Then, solder the three wires from the DC connector in the board to the DC jack as follows:

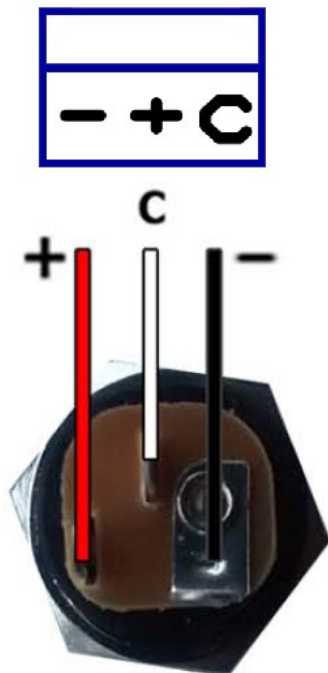

STEP 9 - 3PDT

A - Solder the pin to the adapter

Pay attention, the pins and the 3PDT must be soldered to the same side of the PCB adapter (the one labeled "buttons and 3PDT on this side").

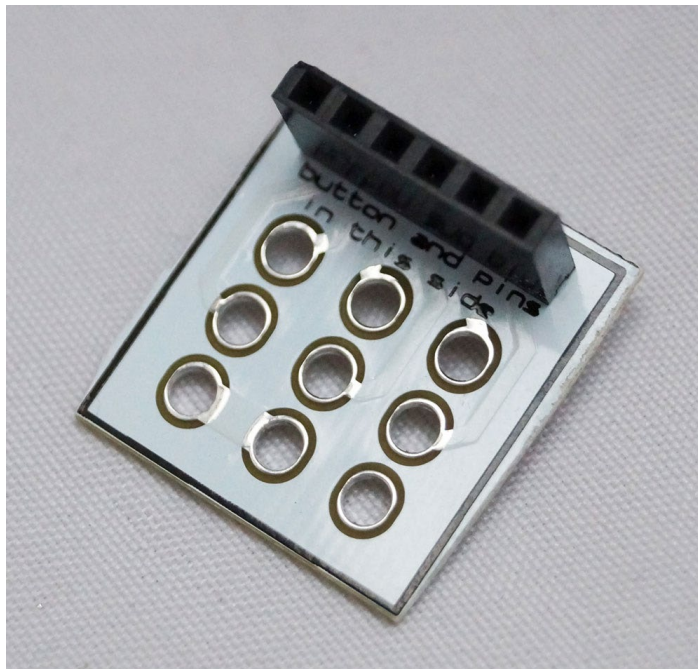

B - Solder the 3PDT

Now solder the 3PDT to the PCB and remove all the nuts but one, that should be set at a middle height:



C – Solder the 3PDT directly to the board (optional)

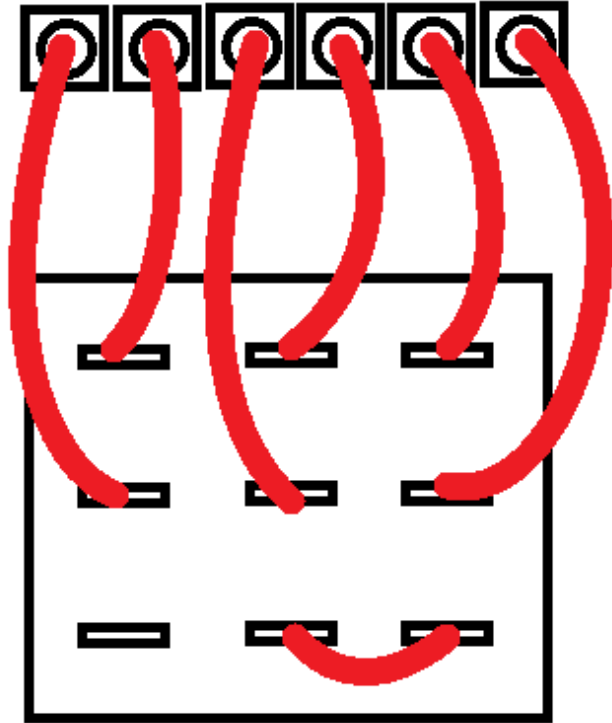

If you prefer to solder the 3PDT directly to the board, you can wire it as shown in the schematic. We recommend to use the **provided 3PDT PCB adapter** to make the soldering easier.

STEP 10 - Connect the 3PDT

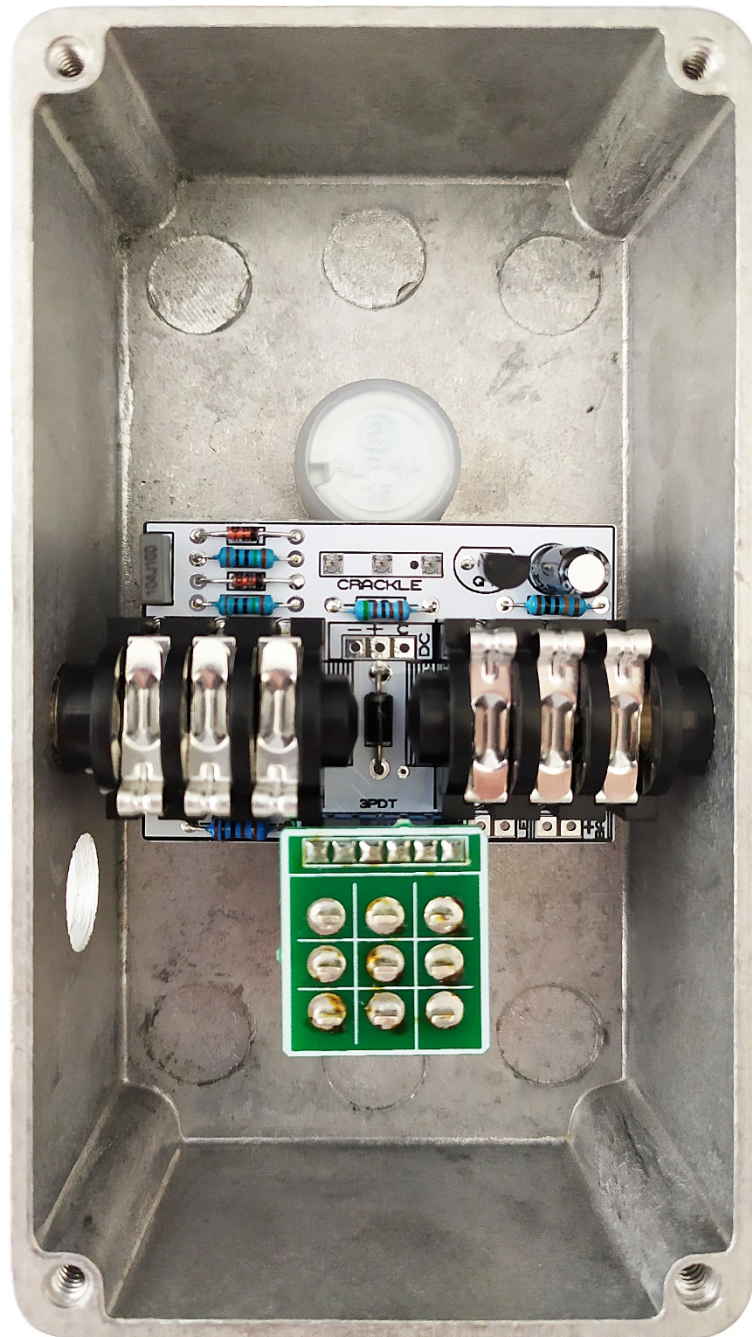

STEP 11 - Your pedal is finished!

By now you should have a fully functional effect pedal, we hope you enjoy it!